



## Description

### Lipari

Its traditional line represents a classic solution for all tastes. Ideal for both residential use (villas, private gardens) and for commercial use (hotels, restaurants...). Fine wood framework treated with a protective coating, steel hardware. Easy opening system with pulley. Lipari can be supplied with a freestanding base or in-ground mount. All FIM products are designed and made in Italy, using the best materials for outdoor use, in order to guarantee exceptional durability even under the most demanding environmental conditions.

Drawings

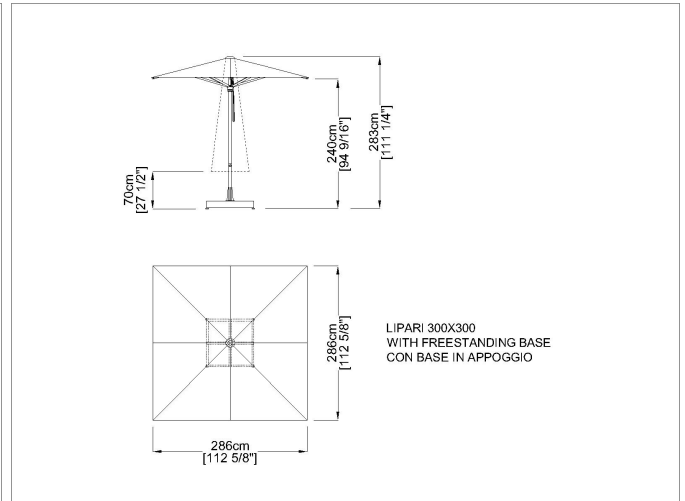
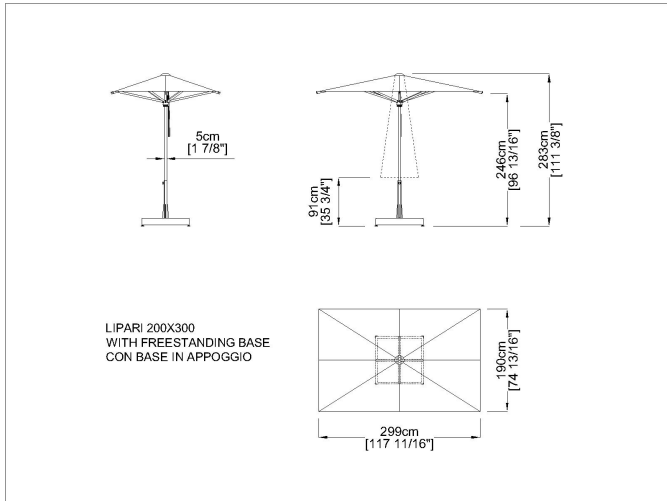

200 x 300

300 x 300

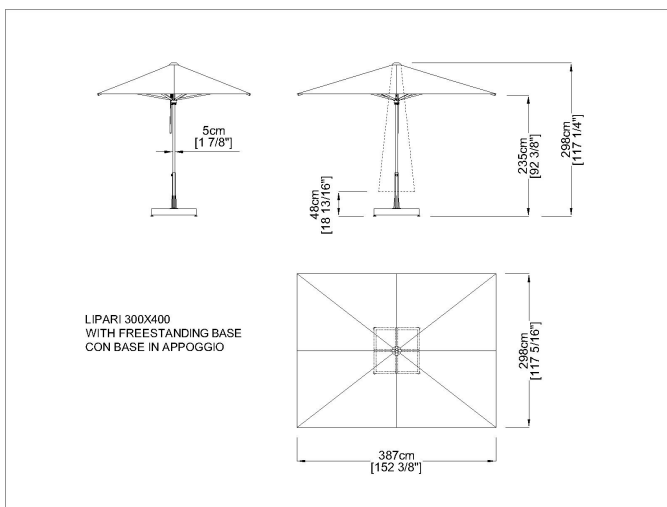

300 x 400

Materials

Acrylic fabric

Water repellent and stain-resistant acrylic fabric. Available in Ecrù (raw) colour. The ideal fabric, excellent value. 290 gr/m<sup>2</sup>.

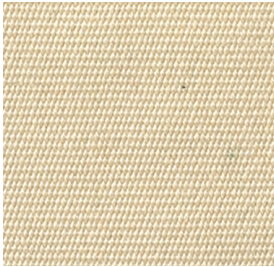

A00 Ecrù  
A00

Solution dyed Acrylic Fabric

Designed for outdoor use, the solution (spun) dyed acrylic fabric resists salt water, chlorine and any type of harsh climate. Colours do not bleed and remain vibrant for a long time. A specific treatment makes the fabric water repellent, mould resistant and protects it from staining. This type of fabric resists the most extreme conditions and is suitable for year-round use in gardens, terraces, pool sides or on-board boats. It's definitely the top choice canopy fabric to select for your Product. UPF 50+ (UV Protection Factor) 280 gr/m<sup>2</sup>.



N01 Sooty  
10030

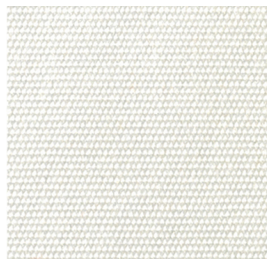

S00 Natural  
5404



S01 Canvas  
5423

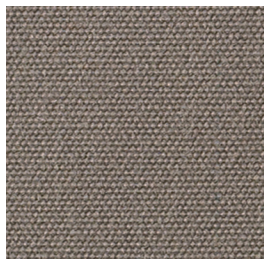

S04 Taupe  
3729

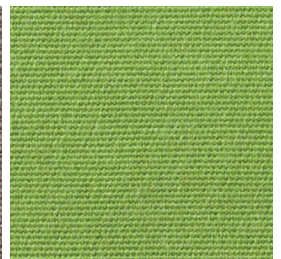

S06 Macao  
3738

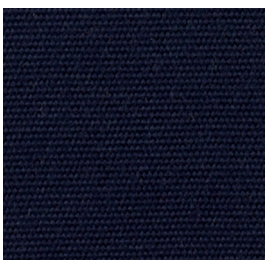

S09 Navy Blue  
5439



S13 Black  
5408

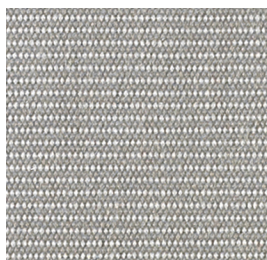

S16 Shingles  
3706



S30 Blue Storm  
3942



S33 Mimosa  
3938



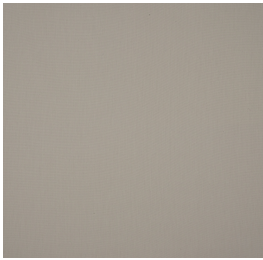

S35 Stone  
3988

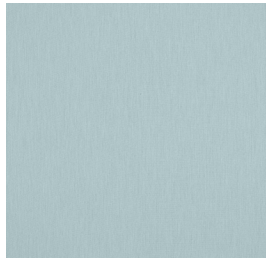

S37 Curacao  
3964

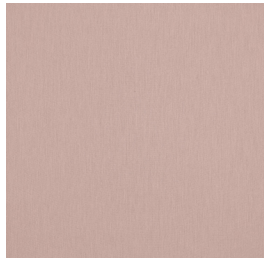

S38 Blush  
3965

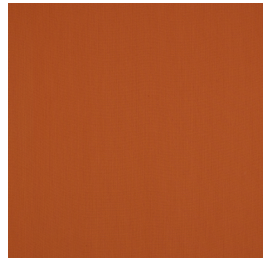

S39 Pumpkin  
3969

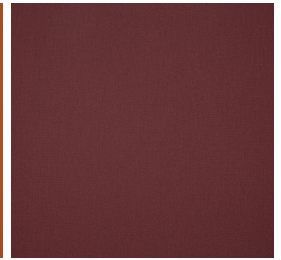

S40 Autumn  
3882

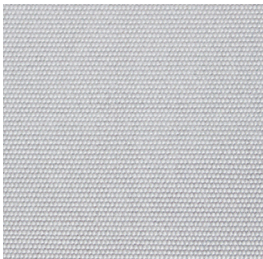

Z02 Silver grey  
3741



Z03 Lin  
3780

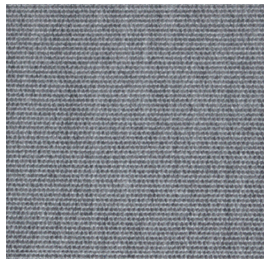

Z09 Lead Chiné  
3756

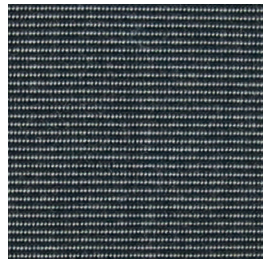

Z14 Charcoal  
3705

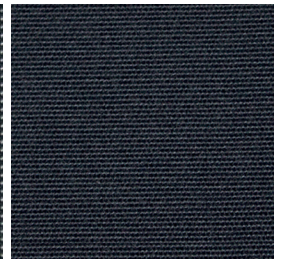

Z15 Carbon  
3906



Z18 Flanelle  
3757

### Solution dyed Acrylic Fabric - Special colours

Designed for outdoor use, the solution (spun) dyed acrylic fabric resists salt water, chlorine and any type of harsh climate. Colours do not bleed and remain vibrant for a long time. A specific treatment makes the fabric water repellent, mould resistant and protects it from staining. This type of fabric resists the most extreme conditions and is suitable for year-round use in gardens, terraces, pool sides or on-board boats. It's definitely the top choice canopy fabric to select for your Product. UPF 50+ (UV Protection Factor) 280 gr/m<sup>2</sup>.

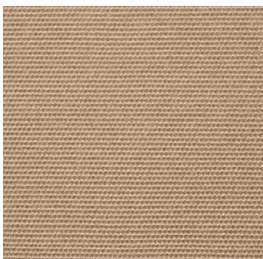

Z04 Antique Beige  
5422

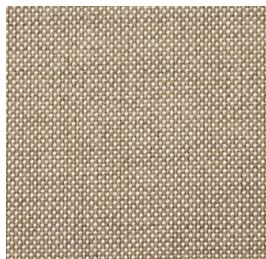

Z05 Arbor Pebble  
48009

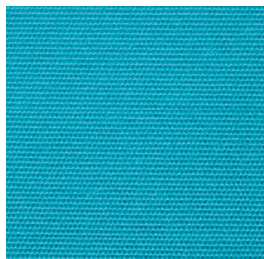

Z06 Aruba  
5416

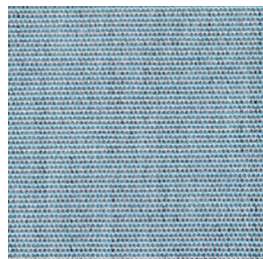

Z08 Mineral Blue Chiné  
3793

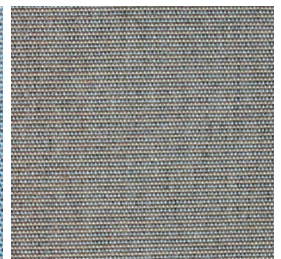

Z10 Taupe Chiné  
3907



## Product Sheet

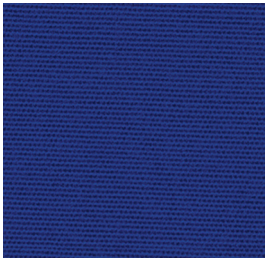

Z11 True Blue  
5499

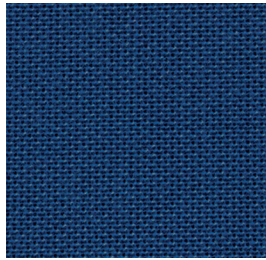

Z12 Riviera Blue  
3717

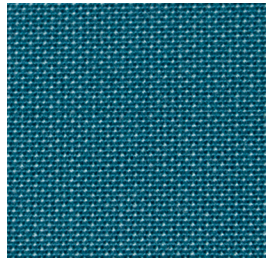

Z13 Adriatic  
3941

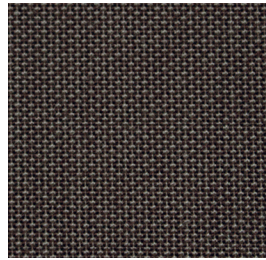

Z17 Mink Brown  
3127



Z19 Dark Smoke  
3729



Z20 Sooty  
3758

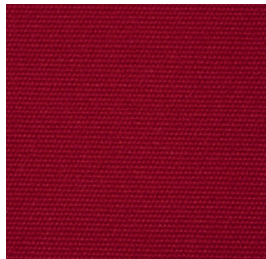

Z23 Paris Red  
3728

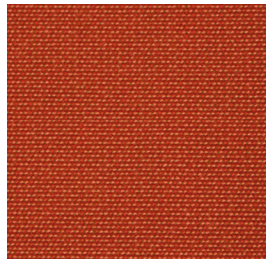

Z30 Paprika  
3939

## Finishes

The materials used have been specifically selected and treated to maintain our products durability and consistency over time. The lumber we source is the best available to guarantee structural integrity and strength of the product. Given the fact that wood is a "living" material and reacts to temperature and humidity variations it can consequently show gaps or imperfections that are not to be considered a defect. They do not alter its resistance qualities, but rather witness its continuous vitality. The aluminum profiles are powder coated or anodized to ensure a longer durability in time. The colors may differ from the real ones.

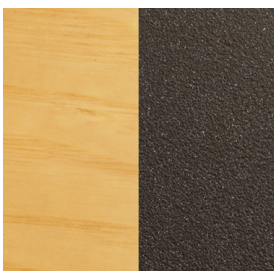

LEG GRAF



Images





## Product Sheet

### Suggested Products



Reflex



Onda